



GIMB Product Guide

Batten mount PIR detector

Overview



The GIMB miniature PIR (passive infrared) presence detector provides automatic control of lighting loads. It is specifically designed for mounting onto a batten style luminaire.

The detector will switch incandescent, fluorescent, compact fluorescent and LED lighting.

The unit detects movement using a PIR sensor and turns the load on. When an area is no longer occupied the load will switch off after a 10 minute time out period.

A selection of fixing washers are supplied to aid fixing to a variety of luminaires.

Detection diagram

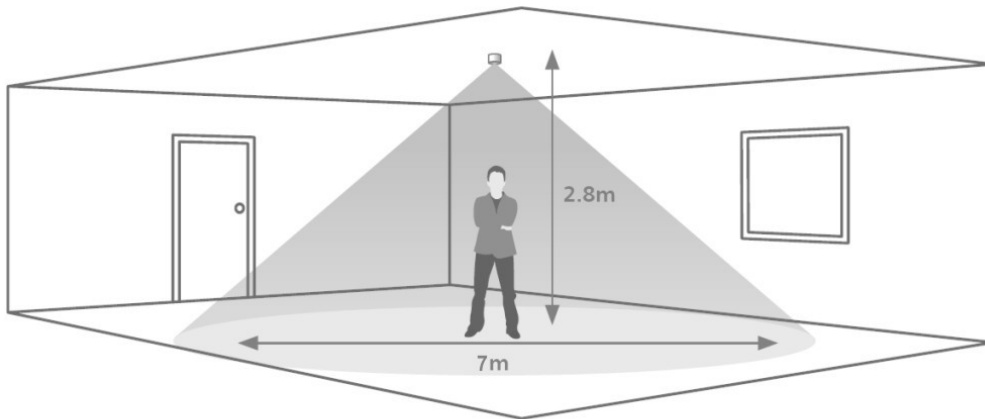

Note: illustration shows an average of the walk across and walk towards figures below.

Walk across

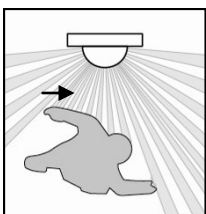

Height	Range Diameter
7m	16m
2.8m	9m

Walk towards

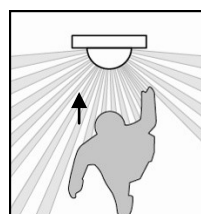



Height	Range Diameter
7m	10m
2.8m	5m

Installation

Do not grip unit at the lens end. Hold the square body near the threaded end when installing and tightening the nut. Care must be taken to prevent damage to the lens and surrounding IP seal.

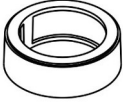
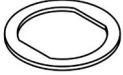
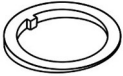
Components

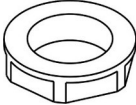
Part	Quantity Supplied
 IP Spacer with silicone coating	1
 Silicone washer	1
 5° washer	1
 5° spacer	1
 M20 nut	1

Mounting hole without key

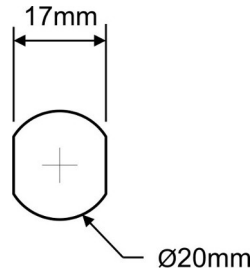

Mounting hole with key

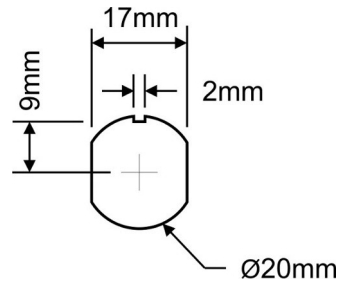

Note. Key to be at top of sensor.

Standard luminaire fitting

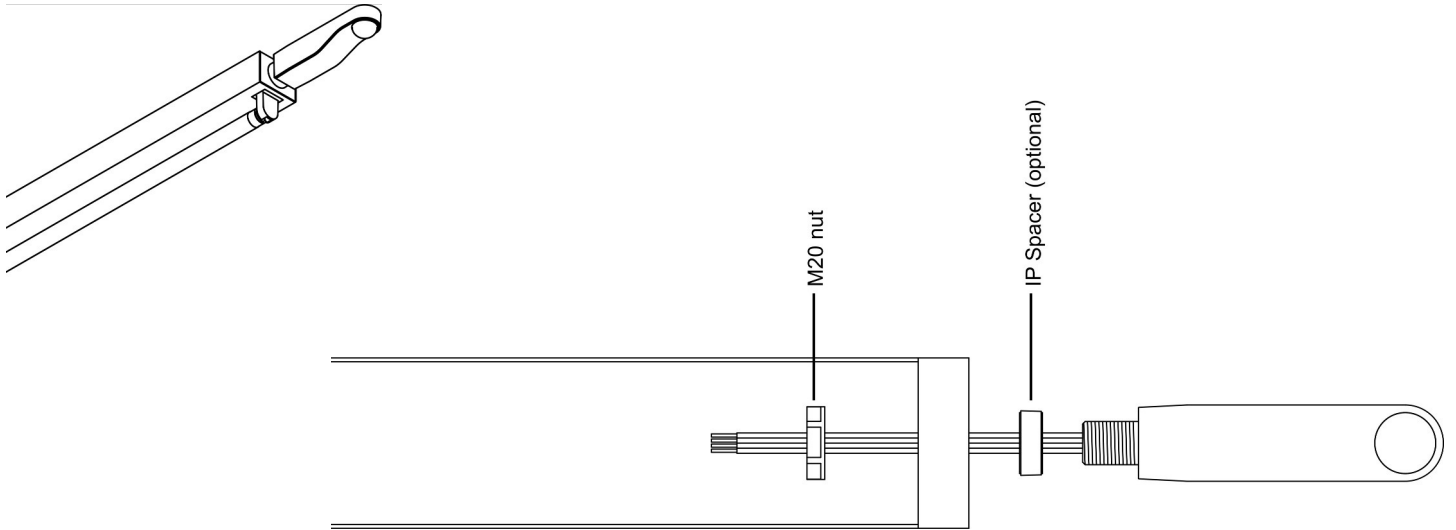

IP luminaire fitting

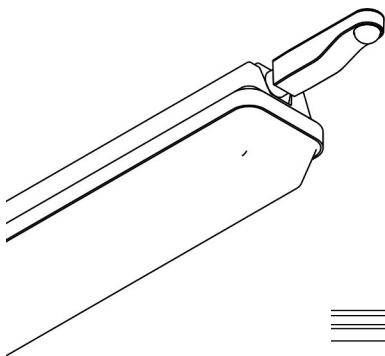

Important
Ensure that the Silicone washer and/or the IP spacer are used to ensure IP rating.

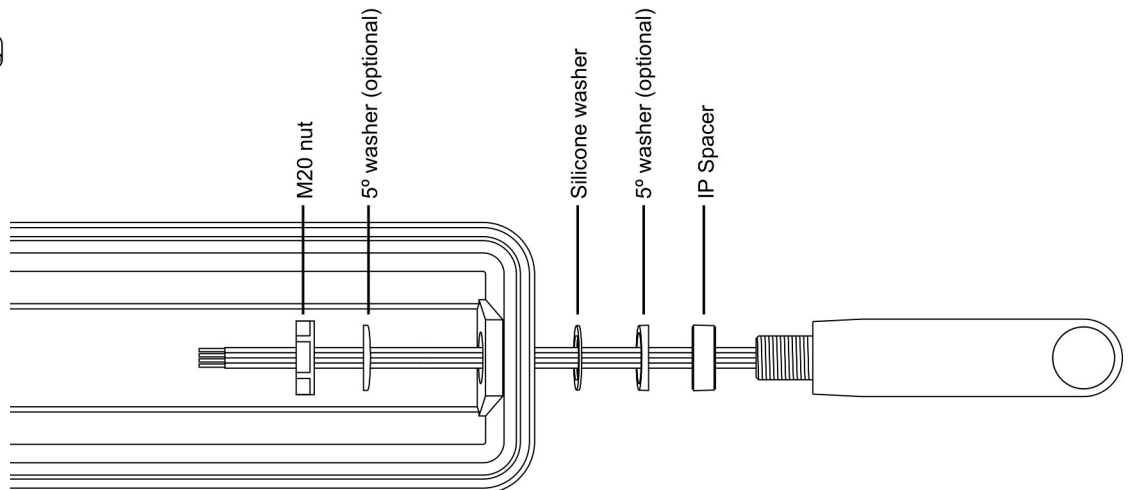

Note. Use the 5° spacers where the luminaire housing has a draft angle.

Installation

The product is designed to be mounted directly to the outside of a luminaire. The detector should be sited so that the occupants of the room fall inside the detection pattern (shown opposite), at a recommended ceiling height of 2.8m. Note that the lower the sensor is installed the smaller the detection range will be, subject to the parameters shown on the detection diagram.

- Do not site within 1m of forced air heating or ventilation..
- Do not fix to a vibrating surface.

Wiring diagram

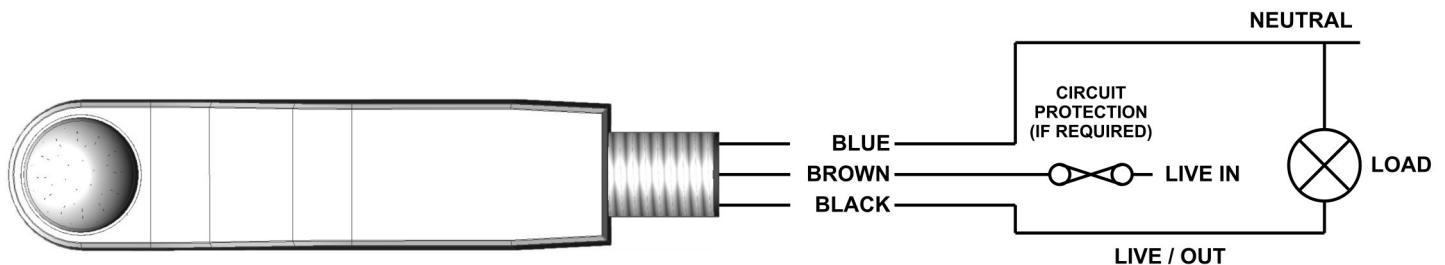

Power-up test procedure

- When power is applied to the unit, the load will turn on immediately.
- For the first 5 minutes of operation the time out period is 10 seconds to aid commissioning.
- Vacate the room or remain very still for more than 10 seconds and wait for the load to switch off.
- Check that the load switches on when movement is detected.
- When the 5 minutes have elapsed the time out will be 10 minutes.

Fault finding

What if the load does not turn ON?

- Check that the live supply to the circuit is good.
- Check that the load is functioning by bypassing the sensor (e.g. link L and L/ Out).

What if the load does not turn OFF?

- Ensure that the area is left unoccupied for longer than the 10 minute time out period.

Technical data

Dimensions	See diagrams opposite.
Weight	0.10kg
Supply Voltage	230VAC +/- 10%
Frequency	50Hz
Maximum Switching Load	2 Amps fluorescent and incandescent lighting. 2 Amps compact fluorescent lighting. 2 Amps low energy lighting. 2 Amps low voltage lighting (switch primary of transformer). Switch SON lighting loads via a contactor.
Power consumption	On 799mW, Off 807mW
Cable specification	1m 1/1.13 solid core cable 105°C
Temperature	-10°C to 35°C
Humidity	5 to 95% non-condensing
Material	Flame retardant ABS/PC
Type	Class 2
IP rating	IP65
Compliance	EMC-2004/108/EC LVD-2006/95/EC

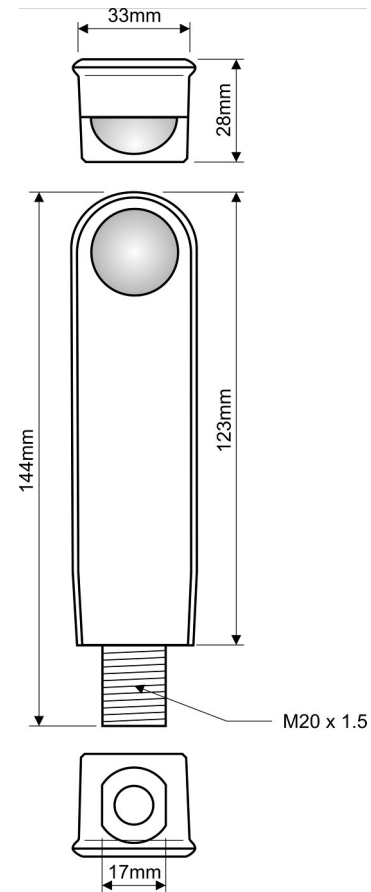

IMPORTANT NOTICE!

This device should be installed by a qualified electrician in accordance with the latest edition of the IEE Wiring Regulations and any applicable Building Regulations.



C.P. Electronics Ltd
Brent Crescent
London
NW10 7XR
United Kingdom
Tel: + 44 (0) 333 900 0671
Fax: + 44 (0) 333 900 0674
www.green-iswitches.co.uk
enquiry@green-iswitches.co.uk